

MODELLING AND SIMULATION OF STATIC VAR COMPENSATOR (SVC) IN POWER SYSTEM STUDIES BY MATLAB

Houari BOUDJELLA*, Fatima Zohra GHERBI*, Fatiha LAKDJA**

* *Intelligent Control and Electrical Power System Laboratory, University of Sidi-Bel-Abbes, Algeria (e-mail: boudj_h@yahoo.fr)*

** *Department of electrical engineering University of Saida, Algeria, e-mail: flakdja@yahoo.fr*

Abstract: This paper presents the modelling and simulation of Static Var Compensator (SVC) in power system studies by MATLAB. In the first step, we have modeled mathematically with MathCAD how to analyze the rating of SVC (Boudjella, 2008). In second step, we have conferred modelling of SVC in power system to analyze its behaviour operating with in control range and outside of control range and how to perform power system studies which is anchored with load flow analysis for SVC realization. In the third step, we have been modelling separately the SVC transfer functions with open control loop in the respective control elements: measuring module, thyristor susceptance control module and voltage regulator module, and we have used lag/led compensators theories to configure open and close loop transfer function with respective gain/phase margin. At the final step, we have controlled the voltage and the reactive power transit in the power system, by SVC device.

Keywords: FACTS, SVC, Var, voltage control.

1. INTRODUCTION

The SVC is a shunt device of the FACTS family using power electronics to control power flow and improve transient stability on power grids. The SVC has been used for reactive power compensation since the mid 1970, firstly for arc furnace flicker compensation and then in power transmission systems. One of the first 40 Mvar SVC was installed at the Shannon Substation of the Minnesota Power and Light system in 1978. The SVC results in the following benefits (Xiao-Ping, et al., 2006): voltage support, and regulation; transient stability improvement, power system oscillation damping; reactive power compensation; power transfer capacity increase and line loss minimization.

Controlled reactive compensation in electric power system is usually achieved with the following configuration corridors: thyristor controlled reactor (TCR), fixed capacitor (FC), thyristor switched capacitor/reactor (TSC/TSR) and mechanical switched capacitor/reactor SVC.

In this paper, we are discussing TCR/TSR SVC combination and its control system shown in Fig.1 (Boudjella, 2008; Noroozian, 1996). The output of the compensator is controlled in steps by sequentially switching of TCRs and TSCs. By stepwise switching of reactors rather than continuous control, the need for harmonics filtering as part of the compensator scheme is eliminated.

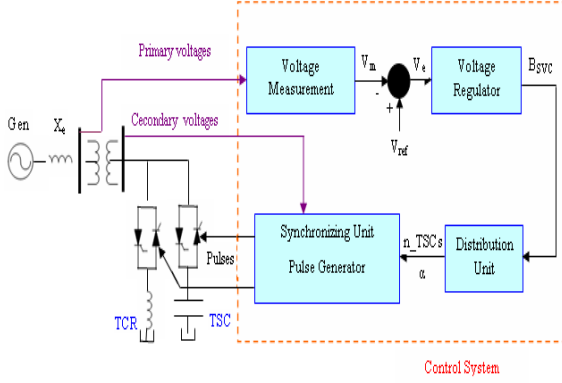

Fig.1. Single-line Diagram of an SVC and Its Control system.

2. SVC MATHEMATICAL MODEL WITH MATHCAD

The following example shows how the parameters of the SVC can be determined. Assume the SVC comprising of one 109-Mvar TCR bank and three 94 Mvar TSC banks connected to the 735 kV bus via a 333 MVA, 735/16 kV transformer on the secondary side with the leakage reactance of the transformer ($X_k=15\%$). The voltage drop of the regulator is 0.01pu/100VA (0.03pu/300 VA). When the SVC operating point changes from fully capacitive to fully inductive, the SVC voltage varies between 1 - 0.03 = 0.97 p.u and $1+ 0.01 = 1.01$ p.u (Boudjella, 2008; Noroozian, 1996).

The SVC rating is as follows:

$$Q_{TSC} = 3 \cdot 94 \text{ Mvar}, \quad Q_{TCR} = 109 \text{ Mvar},$$

a) At rated line-to-line voltage U_{rated} , the nominal inductive and capacitive currents of SVC referred to primary side are determined as follows:

$$(1) \quad Q_{L \text{ rated}} = \sqrt{3} U_{\text{rated}} \cdot I_{L \text{ rated}} = U_{\text{rated}}^2 \cdot B_{L \text{ rated}}$$

$$I_{L \text{ rated}} = \frac{Q_{L \text{ rated}}}{\sqrt{3} U_{\text{rated}}} = \frac{Q_{3TSC} - Q_{TCR}}{\sqrt{3} U_{\text{rated}}} = 135.89 \text{ A}$$

$$(2) \quad Q_{C \text{ rated}} = \sqrt{3} U_{\text{rated}} \cdot I_{C \text{ rated}} = U_{\text{rated}}^2 \cdot B_{C \text{ rated}}$$

$$I_{C \text{ rated}} = \frac{Q_{C \text{ rated}}}{\sqrt{3} U_{\text{rated}}} = \frac{Q_{3TSC}}{\sqrt{3} U_{\text{rated}}} = 221.51 \text{ A}$$

b) At the maximum line-to-line voltage $U_{max} = 742.35 \text{ Kv}$

$$Q_{L \text{ max}} = \sqrt{3} U_{\text{max}} \cdot I_{L \text{ max}} = U_{\text{max}}^2 \cdot B_{L \text{ rated}}$$

$$(3) \quad I_{L \text{ max}} = I_{L \text{ rated}} \frac{U_{\text{max}}}{U_{\text{rated}}} = 137.24 \text{ A}$$

c) At the minimum line-to-line voltage $U_{min} = 712.95 \text{ kV}$

$$(4) \quad Q_{C \text{ min}} = \sqrt{3} U_{\text{min}} \cdot I_{C \text{ min}} = U_{\text{min}}^2 \cdot B_{C \text{ rated}}$$

$$I_{C \text{ min}} = I_{C \text{ rated}} \frac{U_{\text{min}}}{U_{\text{rated}}} = 214.86 \text{ A}$$

The reactive of the TCR and TSC are calculated as

$$X_{L \text{ rated}} = \frac{U_{\text{rated}}^2 S}{Q_{L \text{ rated}}} = \frac{16^2}{109} = 2.348 \Omega$$

$$X_{\text{transf}} = 0.15 \cdot \frac{U_{\text{rated}}^2}{P_{\text{trans}}} = \frac{16^2}{333} = 0.115 \Omega$$

$$(5) \quad X_{L \text{ TCR}} (\Delta) = X_{L \text{ rated}} - X_{\text{transf}} = 2.233 \Omega$$

$$X_{L \text{ TCR}} (1\Phi) = 3 \cdot 2.233 = 6.67 \Omega$$

$$L_{L \text{ TCR}} = \frac{6.67}{2 \cdot \pi \cdot 60} = 17.7 \text{ mH}$$

$$(6) \quad X_{C \text{ rated}} = \frac{U_{\text{rated}}^2}{Q_{C \text{ rated}}} = \frac{16^2}{282} = 0.9078 \Omega$$

$$C = \frac{1}{2 \cdot \pi \cdot 60 \cdot 0.9078} = 2.92 \text{ mF}$$

3. SVC V-I CHARACTERISTICS

The steady-state and dynamic characteristics of SVCs describe the variation of SVC bus voltage with SVC current or reactive power, Fig.2 illustrates the terminal voltage-SVC current characteristic with specific slope (Boudjella, 2008; Acha, et al., 1996).

$$(7) \quad \text{Slope} = \frac{\Delta V_{C \text{ max}}}{I_{C \text{ max}}} = \frac{\Delta V_{L \text{ max}}}{I_{L \text{ max}}}$$

The regulation slope allows:

- To extend the linear operating range of the compensator.
- To improve the stability of the voltage regulation loop.
- To enforce automatic load sharing between static var compensator as well as other voltage regulation devices.

The V-I characteristic is described by the following three equations:

$$(8) \quad V = V_{\text{ref}} + X_S \cdot I \quad \text{SVC is in regulation rang}$$

$$(9) \quad V = \frac{I}{-B_{C \text{ max}}}$$

SVC is fully capacitive $B = B_{C \text{ max}}$

$$(10) V = \frac{I}{B_{L \max}}$$

SVC is fully inductive $B = B_{L \max}$

The voltage at which SVC neither absorbs nor generates reactive power is the reference voltage V_{ref} see in figure (2). In practical this voltage can adjusted within the typical range of $\pm 10\%$. The slope of the characteristics reflects a change in voltage with compensator current and, therefore can be considered as slope reactance X_{SL} , resulting the SVC response to the voltage variation and is then

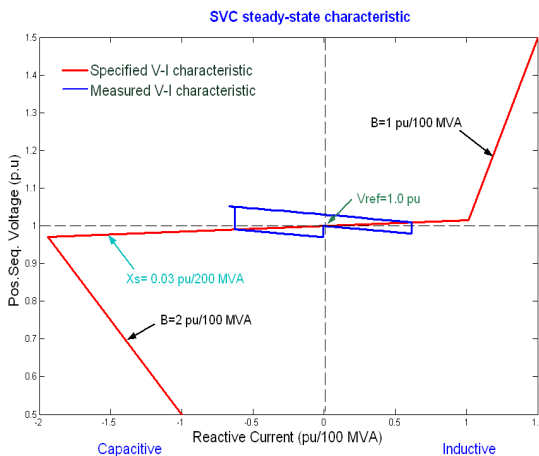

Fig.2. SVC steady-state control characteristics.

4. MODELING OF STATIC VAR COMPENSATOR IN POWER SYSTEM STUDIES

SVC application studies require appropriate power system models and study methods covering the particular problems to be solved by the SVC application. The following studies normally are required for an SVC application from the early planning stage till operation (Acha, et al., 2004; C.E.Lin, et al., 1988; Lakdja, 2005).

- Load flow studies.
- Small and large disturbance studies.
- Harmonic studies.
- Electromagnetic transient studies.
- Fault studies.

4.1. Model for load flow analysis

The main objective of load flow analyses is to determine the node voltages reactive and active power flow in the network branches, generations and loss. The power flow studies related to SVC applications are (Acha, et al., 2002; Chi, et al., 1992; Noroozian, 1996):

- Determine the location and preliminary rating of the SVC.

- To render information on the effects of the SVC on the system voltages and power flows.

- To provide the initial condition for system transient analysis.

- And operating boundaries likewise inside or outside control range.

4.2. SVC Operating within the control range

The control range of the SVC is defined as:

$$I_{\min} < I_{SVC} < I_{\max} \dots V_{\min} < V < V_{\max}$$

In this range, SVC is represented as a PV-node (generator node) at an auxiliary bus with $P=0$, $V = V_{\text{ref}}$. A reactance of equivalent to the slope the V-I characteristics is added between the auxiliary node and the node of coupling to the system. The node at the point of common coupling is a PQ node with $P=0$, $Q=0$, as show in Fig.3:

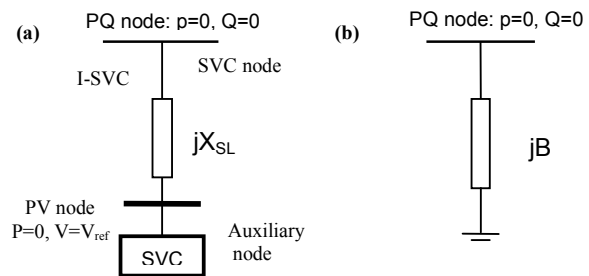

Fig.3. SVC model for operation, a) within the control range, b) outside the control range.

5. SVC CONTROL TRANSFER FUNCTION MODELED BY MATLAB

The SVC modelling comprises of following elements (Boudjella, 2008; Noroozian, 1996):

- The voltage and current measuring (and filtering) circuit.
- A regulator including possible additional signals fed to the reference point.
- Additional control signals are used for system damping improvement.
- A distribution unit.
- A model of the Thyristor susceptance control module.
- A model of the interface with the power system.

5.1. Measuring module

In SVC model, the characteristics of the measuring and filter circuit can be approximated by transfer function as given below:

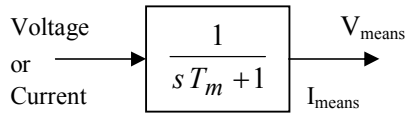

The measuring circuit time constant is 0.001-0.005s

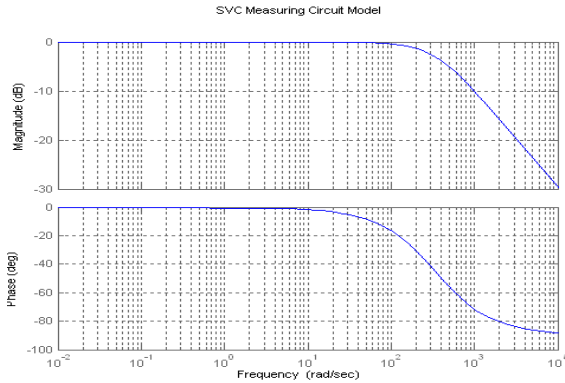
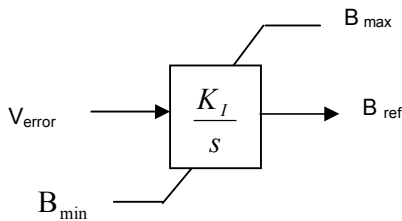

Fig.4. Measuring model.

5.2. Measuring module



For this example $K_i = 300$.

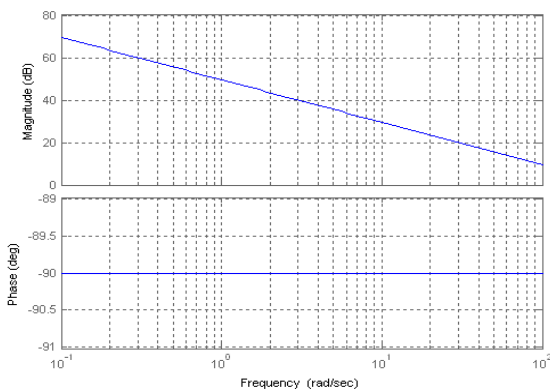
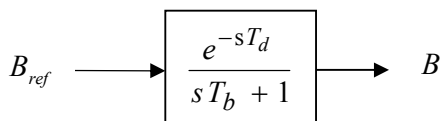

Fig.5. Voltage Regulator Model integral type.

5.3. Thyristor susceptance control model



T_d is the gating delay or (dead time) is neglected as it is very small ($\approx 1/12$ th cycle of the fundamental) and T_b is the effect of Thyristor firing sequence control.

The compensator susceptance, B_{SVC} is given by:

$$(11) \quad B_{SVC} = \frac{B_0 (B_{TSC} + B_{TCR})}{B_0 + B_{TSC} + B_{TCR}}$$

Where B_0 is the susceptance of the transformer.

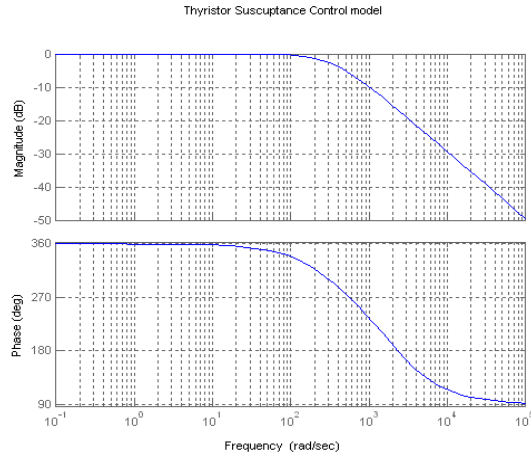

Fig.6. Susceptance control model.

5.4. Distribution unit module

The function of a distribution module is to determine the number of TSC units and the level of TCR reactive power absorption (or a combination of both) based on the required reactive power. For SVC with continuous output, there is not a need to model this module. Fig.7 shows a distribution model for TSR-TSC SVCs (Noroozian, 1996).

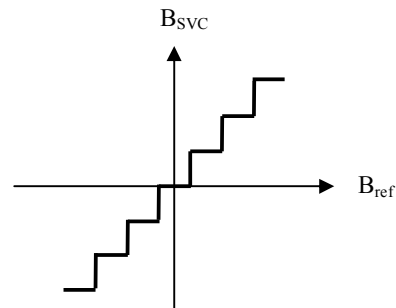

Fig.7. Distribution unit model for TSR-TSC type SVC.

6. TYPICAL PARAMETERS FOR SVC MODELS

The parameters of the SVC have to be selected to SVC rating and performance criteria taking into account the power system behavior under various operating conditions.

To improve SVC strategic operation these parameters are viable (Acha, et al., 2004; Boudjella, 2008).

Table 1: Typical Parameters for SVC Model

Module	Parameter	Definition	Typical value
Measuring	T_m	For time Constant	0.001-0.005s
Thyristor Control	T_d	Gating delay	0.001s
	T_b	Firing delay	0.003-0.006s
Voltage regulator	K_i	Integrator gain	K_i can be adjusted
Slope	X_{SL}	Steady-state error	0.01-0.05 p.u
Module	Parameter	Definition	Typical value
Measuring	T_m	For time Constant	0.001-0.005s

7. SIMPLIFIED TRANSFER CONTROL FUNCTION OF SVC

The system stability studies narrate how to get the substantial results by means of SVC to stabilize system voltages. For this situation the power system is represented by a source voltage in series with an equivalent system reactance X_e in p.u. Fig.8 show a simplified block diagram of the SVC with closed-lope terminal voltage control.

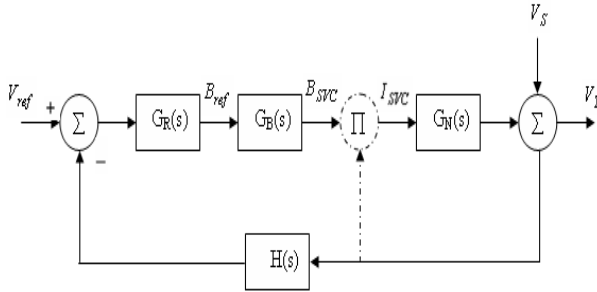

Fig.8. Simplified block diagram of SVC.

In the simplified model:

$H(s) = \frac{1}{1 + sT_m}$: transfer function of the voltage measuring device.

$G_R(s) = \frac{K_{SL}}{1 + sT}$: transfer function of voltage regulator and slope unit.

$G_B(s) = \frac{1}{1 + sT_d}$: transfer function of the compensator main circuit.

$G_N(s) = X_e$: transfer function of the network.

The slope of the steady-state characteristics is related to transfer function gain $K_{SL} = \frac{1}{X_{SL}}$

For simplified model, we have:

$$(12) \Delta V_T(s) = \frac{G_R(s)G_B(s)G_N(s)}{1 + G_R(s)G_B(s)G_N(s)H(s)} \Delta V_{ref}(s) + \frac{1}{1 + G_R(s)G_B(s)G_N(s)H(s)} \Delta V_s(s)$$

7.1. SVC Model example

This example shows how to control SVC model for determination of the SVC node voltage variation due to a small disturbance.

$Q_{rated}=180$ Mvar, power system $S_C= 1800$ MVA, $X_{SL}= 2\%$. $T_m=0.003s$, $T=0.02s$, $T_d = 0.001s$.

7.2. SVC Plant Designing

Effect of voltage regulation and slope with transfer function:

$$G_R(s) = \frac{K_{SL}}{1 + sT}$$

$$K_{SL} = \frac{1}{X_{SL}} = 50 \text{ p.u}$$

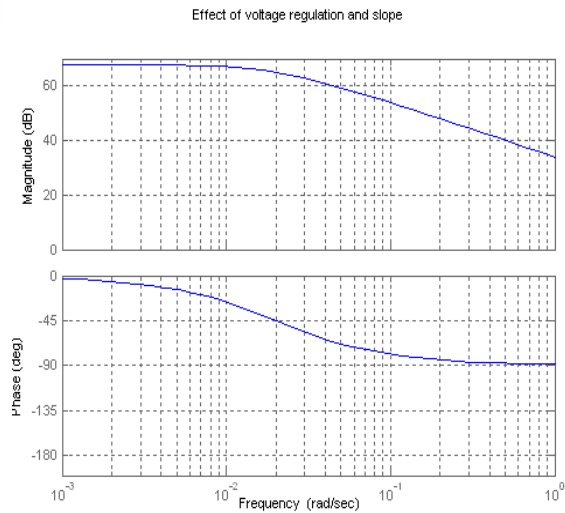

Fig.9. Effect of voltage regulation and slope.

SVC transfer function of voltage measuring device outcomes is given by Fig.4.

$$H(s) = \frac{1}{1 + sT_m}$$

7.3. SVC Control Compensator Designing

$$G_B(s) = \frac{1}{1 + sT_d}$$

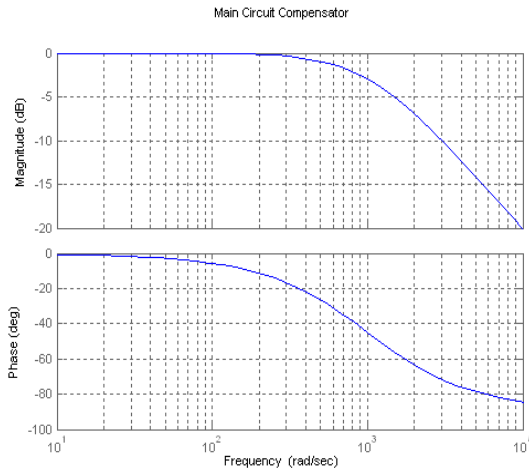

Fig.10. Compensator main circuit.

On the base of SVC rating, we have:

$$(13) X_e = \frac{Q_{rated}}{S_C} = \frac{180}{1800} = 0.1 \text{ p.u.}$$

Suppose that the $\Delta V_{ref} = 0$ the response of the system to a step-like voltage ΔV_s is formulated as:

$$(14) \frac{\Delta V_T(s)}{\Delta V_S(s)} = \frac{1}{1 + G_R(s)G_B(s)G_N(s)H(s)}$$

In the steady-state ($s \rightarrow 0$):

$$(15) E_{ss(s \rightarrow 0)} = \frac{\Delta V_T(s)}{\Delta V_S(s)} = \frac{1}{1 + X_{SL}X_e} = \frac{1}{1 + 50 \times 0.1} = 0.17$$

This means that the variation of voltage in the SVC node is equivalent to 17% of the variation of the source voltage.

8. LOCATION OF AN SVC

Location of an SVC strongly affects controllability of the swing modes. In general the best location is at a point where voltage swings are greatest. Normally, the mid-point of a transmission line between the two areas is a good candidate for placement.

9. PRINCIPLE OF SVC OPERATION

Thyristor Controlled Reactor (TCR): is a fixed reactor in series with bidirectional Thyristor valve. The amplitude of the TCR current can be changed continuously by varying the Thyristor firing angle from 90° to 180° . The TCR firing angle can be fully changed within one cycle of the fundamental

frequency, thus providing smooth and fast control of reactive power supply to the system (Acha, et al., 2004; Acha, et al., 2002).

Thyristor Switched Capacitor (TSC): comprises of a capacitor in series with bidirectional Thyristor valve and a damping reactor, used to switch on and off the capacitor bank. The TSC can operate in coordination with the TCR so that the sum of the reactive power from the TSC and the TCR becomes linear.

10. EFFECT OF AN SVC LOCATION IN TRANSMISSION LINE

We take the example of the paragraph (§.2), after simulation by Matlab, we have obtained the waveforms of the SVC (Boudjella, 2008; Hubbi, et al., 1998):

The SVC equivalent susceptance seen from the primary side can be varied continuously from -1.04 p.u/100 MVA (fully inductive) to +3.04 p.u/100 Mvar (fully capacitive). This susceptance is the image of the reactive power of SVC compensator.

Initially the source voltage is set at 1.004 p.u, resulting in a 1.0 p.u voltage at SVC terminals when the SVC is out of service (fig.11.b). The SVC is initially floating (zero Current). This operating point is obtained with TSC1 in service and TCR almost at full conduction, $\alpha = 96^\circ$ (fig.12.a).

At $t=0.1s$ voltage is suddenly increased to 1.025 p.u. The SVC reacts by absorbing reactive power $Q=-95$ Mvar (fig.11.d) to bring the voltage back to 1.01 p.u.

The 95% settling time is approximately 135 ms. At this point all TSCs are out of service (fig.12.b) and the TCR is almost at full conduction $\alpha = 94^\circ$ (fig.12.a).

At $t = 0.4 s$ the source voltage is suddenly lowered to 0.93 p.u The SVC reacts by generating 256 Mvar of reactive power, thus increasing the voltage to 0.974 p.u. At this point the three TSCs are in service and the TCR absorbs approximately 40% of its nominal reactive power ($\alpha = 94^\circ$).

Finally, at $t=0.8 s$ the voltage is increased to 1.0 p.u and the SVC reactive power is reduced to zero.

11. CONCLUSIONS

In this article, we have modeled the small disturbances including control action, resulting in the determination of the required rating of SVC for the given subject matter. Furthermore, it has also determined the appropriate control signal for adequate transient stability as well as control structures corridors to give most viable and composite perception of the SVC control system.

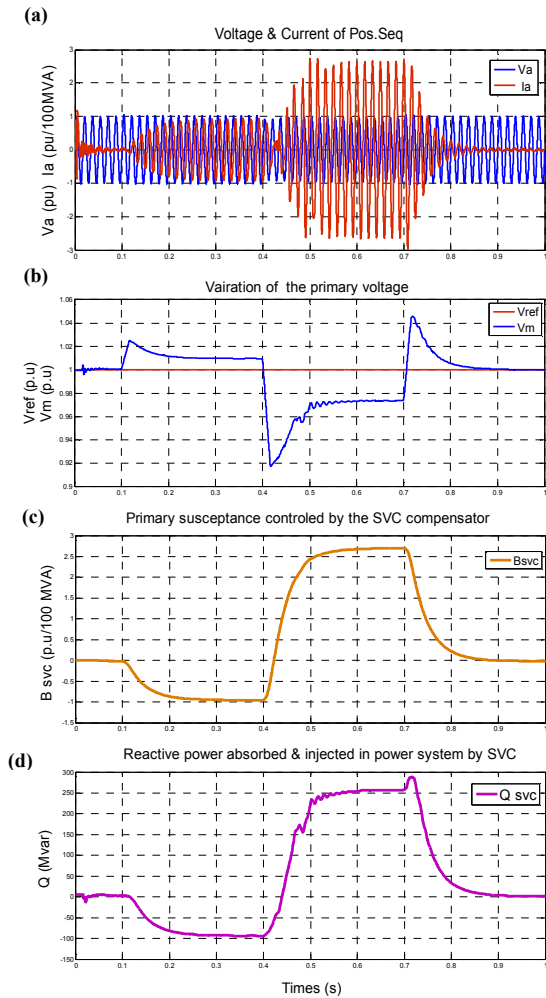

Fig.11. Simulation of the dynamic response of the SVC

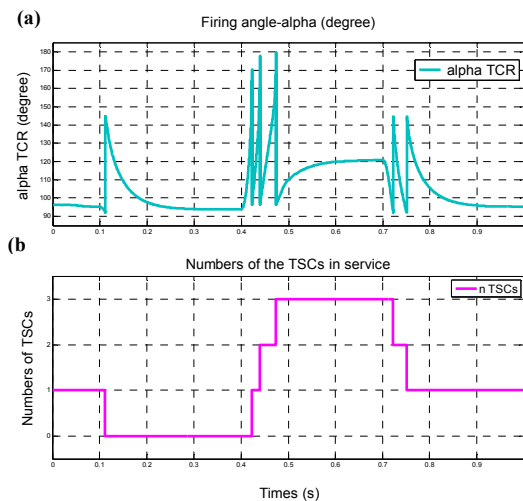

Fig.12. Signals command generated by the SVC control system

Therefore, the power system stability describes the voltage control at the point of SVC connection to the system. This technique may be used to verify the adequacy of the control parameters. And finally, we connect an SVC on a power grid to control the voltage and the reactive power.

12. REFERENCES

- Acha. E, Esquivel. C.R.F, Perez. H.A, Camacho. C.A (2004): *FACTS modelling and simulation in power system Networks*. 421pp. Chap 2. John Wiley & Sons Ltd, British Library.
- Acha. E, Agelidis. V.G, Anaya-Lara. O, Miller. T.J.E (2002): *Power Electronic Control in Electrical Systems* 451pp. Chap 6 & 9. Newnes Publisher.
- Xiao-Ping. Z, Rehtanz. C, Bikash. P (2006): *Flexible AC Transmission Systems: Modelling and Control*. 395pp. Chap.2, Springer Berlin Heidelberg New York.
- Ambriz- P'erez. H, E. Acha, C. R. Fuerte-Esquivel (2000): Advanced SVC Models for Newton-Raphson Load Flow and Newton Optimal Power Flow Studies. *IEEE Transactions on Power Systems*.
- Chi. W.J, Wu. C.J (1992): Voltage profile correction of a load bus by static reactive power compensators with contization controllers. *Electric Power System Research*, PP 47-58.
- Gérin -Lajole.L, G.Scott, S. Breault, E. V Larsen, D. H. Baker and A. F. Imece (1990): *Hydro - Québec Multiple SVC Application Control Stability Study*. *IEEE Transactions on Power Delivery*, pp .1543-1551.
- Hubbi. W, Hiyama. T (1998): Placement of static var compensator to minimize power system losses. *Electric Power Systems Research*, PP 95-99.
- Lin. C.E, Chen. T.C, Huang. C.L (1988): Optimal control of a static var compensator for minimization of line loss. *Electric Power Systems Research*, PP 51-61.
- Noroozian. M (1996): Modelling of SVC power system studies. *ABB Power Systems Division, information NR500-026E*, Sweden.
- Boudjella. H (2008): *Contrôle des puissance réactive et des tension sur un réseau de transport au moyen de dispositifs SVC*. Mémoire de magister, université de Sidi Bel Abbes, Algérie.
- Gherbi. F.Z.I (2004): *Contribution a l'étude de la répartition économique des puissances actives et réactives dans un réseau d'énergie électrique*. Thèse de doctorat d'état, UDL, Sidi Bel Abbes, Algérie.
- Lakdja. F (2005): *Contrôle des transits de puissance par dispositifs FACTS: Application à un réseau d'énergie électrique*. Mémoire de magister, ENSET, Oran, Algérie.