

PERFORMANCE COMPARISON OF SLIDING MODE CONTROLLER AND CONVENTIONAL PID CONTROLLER FOR DC MOTOR

Razvan Solea¹, Marian Gaiceanu¹, Bogdan Codres¹ and Cristian Eni²

¹"Dunarea de Jos" University of Galati, Stiintei Street, No.2, Romania,
rsolea@ugal.ro, marian.gaiceanu@ugal.ro, bogdan.codres@ugal.ro

²SC Galfinband SA, Galati, Romania, office@galfinband.ro

Abstract: This paper is concerned with the performance comparison of Sliding Mode Controller and conventional PID Controller for the control of DC Motor. The DC motor can be modeled as a linear time invariant single input single output (SISO) system. Direct Current (DC) motors have been used extensively in industry mainly because of the simple strategies required to achieve good performance in speed or position control applications. Conventional controllers (such as PID-algorithm) are lack of robustness, therefore disturbances affect the system synchronization and quality of the production. Performance of these controllers has been verified through simulation results using MATLAB/SIMULINK software. The performance of sliding mode controller is superior to conventional PID controllers even in the presence of disturbances.

Keywords: Direct Current Motor, Sliding-mode Control, Milling Process

1. INTRODUCTION

Steel production is still one of the major basic industries with a huge amount of material and energy consumption. Faults on the rolling line system cause to reduce the benefits and to waste time. Most of these causes are due to weak in speed control of the rolling machines and loosing in synchronization of the rolling system.

The line production consists of a specific number of rolling stands depending on type of the product and/or size of its cross-section. Each stand in the rolling system consists of two rolls arranged vertically to shape the production. These rolls are driven by direct current motors (DC-motors).

Direct current motors have occupied a wide spectrum of applications for variable speed drives, because of their simplicity and versatility of control. In the past

three decades, nonlinear and adaptive control methods have been used extensively to control DC and brushless dc motor drives (Cerruto *et al.*, (1992), Hemati *et al.*, (1990), Grcar *et al.*, (1996), Matsui and Ohashi(1992)).

The disadvantage of PID controller is poor capability of dealing with system uncertainty, i.e., parameter variations and external disturbance. In recent years, there has been extensive research interest in robust control systems, where the fuzzy logic, neural network and sliding-mode based controllers. However, the performance of PI controller for speed or position regulation degrades under external disturbances and machine parameter variations. Furthermore, the PID controller gains have to be carefully selected in order to obtain a desired response. This makes the use of traditional PID controller a poor choice for industrial variable speed drive applications where higher dynamic

control performance with little overshoot and high efficiency is required.

Sliding mode control (SMC) is one of the popular strategies to deal with uncertain control systems. After seventies, SMC has become more popular control strategies and powerful control technology to deal with the nonlinear uncertain system. The best property of the SMC is its robustness. Loosely speaking, a system with a sliding mode control is insensitive to parameter variations and external disturbances.

The finite speed of switching devices involved in SMC cause the phenomenon of chattering and it affects the performance of the system adversely. The chattering phenomenon problem is considered as a major obstacle for sliding mode control to become one of the most significant discoveries in modern control theory. Several solutions have been proposed in the research literature to eliminate or reduce the chattering.

2. MATHEMATICAL MODELING OF A DC MOTOR

DC motors are widely used for industrial and electronic equipment where the speed control with high accuracy is required. There are various DC motor types. The electric circuit of the armature and the free body diagram of the rotor are shown in fig. 1.

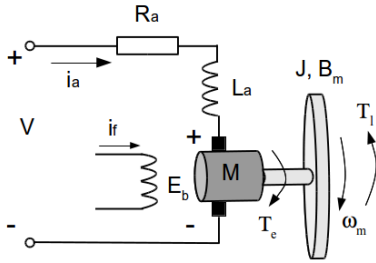

Fig.1. Structure of a DC Motor

The desired speed is tracked according to the shaft position of the motor. A single controller is required to control the position as well as the speed of the motor. The controller is selected so that the error between the system output and reference signal eventually tends to its minimum value, ideally zero. The reference signal determines the desired position and/or speed. Depending on type, a DC motor may be controlled by varying the input voltage or field current.

The dynamics of a DC motor is given below:

$$(1) V = R_a i_a + L_a \frac{di_a}{dt} + E_b$$

$$(2) T_e = K_t i_a = T_l + J \frac{d\omega_m}{dt} + B_m \omega_m$$

$$(3) E_b = K_b \omega_m, \quad \omega_m = \frac{d\theta}{dt}$$

Where V = Applied Voltage, R_a = Lumped armature resistance, L_a = Equivalent armature inductance, i_a = current flowing through armature circuit, K_b = motor constant, E_b = back emf voltage, ω_m = motor speed, T_e = developed torque, T_l = load torque, J = moment of inertia, B_m = damping constant, K_t = motor constant and θ = angular displacement.

Equations (1) – (3) are rearranged to obtain:

$$(4) \frac{di_a}{dt} = \frac{V}{L_a} - \frac{R_a}{L_a} i_a - \frac{K_b}{L_a} \omega_m$$

$$(5) \frac{d\omega_m}{dt} = \frac{K_t i_a}{J} - \frac{T_l}{J} - \frac{B_m}{J} \omega_m$$

In the state space model of a separately excited DC motor, Equations (4) and (5) can be expressed by choosing the angular speed (ω_m) and armature current (i_a) as state variables and the armature voltage (V) as an input. The output is chosen to be the angular speed.

$$(6) \begin{cases} \begin{bmatrix} \frac{di_a}{dt} \\ \frac{d\omega_m}{dt} \end{bmatrix} = \begin{bmatrix} -\frac{R_a}{L_a} & -\frac{K_b}{L_a} \\ \frac{K_t}{J} & -\frac{B_m}{J} \end{bmatrix} \cdot \begin{bmatrix} i_a \\ \omega_m \end{bmatrix} + \begin{bmatrix} \frac{1}{L_a} \\ 0 \end{bmatrix} \cdot V + \\ \begin{bmatrix} 0 \\ -\frac{1}{J} \end{bmatrix} \cdot T_l \\ y = [0 \quad 1] \cdot \begin{bmatrix} i_a \\ \omega_m \end{bmatrix} \end{cases}$$

Table 1 lists the numerical values for the parameters of the separately excited DC motor studied in this paper.

Table 1 Parameters of the DC motor.

Parameters	Values
R_a	0.5 Ω
L_a	1 mH
J	0.001 Kg m ²
B_m	0.01 Nm s/rad
K_b	0.001 V/rad
K_t	0.008 Nm/A

3. DESIGN OF SLIDING MODE SPEED CONTROL OF DC MOTOR

The principle of designing sliding mode control law for arbitrary-order plants is to force the error and derivative of error of a variable to zero. In the DC motor system the speed error and its derivative are the selected coordinate variables those are forced to zero.

For the sliding mode controller technique, the sliding surface is chosen as:

$$(7) \quad \dot{s} = \dot{\omega}_e + \gamma \cdot \omega_e,$$

$$(8) \quad \omega_e = \omega_{ref} - \omega_m$$

where ω_e is the tracking speed error. γ is a strictly positive constant that determine the bandwidth of the system. The given speed control problem can be treated as a regulator problem, where the desired acceleration is chosen to be zero.

Gao and Hung (1993) proposed a reaching law which directly specifies the dynamics of the switching surface by the differential equation

$$(9) \quad \dot{s} = -Q \cdot \text{sgn}(s) - P \cdot h(s)$$

where Q and $P > 0$.

The four practical cases of the equation (9) used in this paper are given below.

A. Constant rate reaching (Gao and Hung (1993))

$$(10) \quad \dot{s} = -Q \cdot \text{sgn}(s)$$

This law forces the switching variable $s(t)$ to reach the switching manifold s at a constant rate $\left| \dot{s} \right| = -Q$. The

merit of this reaching law is its simplicity. But, as we know, if Q is too small, the reaching time will be too long. On the other hand, a too large Q will cause severe chattering.

B. Constant plus proportional rate reaching (Gao and Hung (1993))

$$(11) \quad \dot{s} = -Q \cdot \text{sgn}(s) - P \cdot s$$

Clearly, by adding the proportional rate term $-P \cdot s$, the state is forced to approach the switching manifolds faster when s is large. It can be shown that the reaching time for ω to move from an initial state ω_0 to the switching manifold s is finite, and is given by:

$$t = \frac{1}{P} \cdot \ln \frac{P \cdot |s| + Q}{Q}$$

C. Power rate reaching (Gao and Hung (1993))

$$(12) \quad \dot{s} = -P \cdot |s|^\alpha \cdot \text{sgn}(s), \quad 0 < \alpha < 1$$

This reaching law increases the reaching speed when the state is far away from the switching manifold, but reduces the rate when the state is near the manifold. The result is a fast reaching and low chattering reaching mode. Integrating (12) from $s = s_0$ to $s = 0$ yields

$$t = \frac{|s(0)|^{1-\alpha}}{(1-\alpha) \cdot P}$$

showing that the reaching time t , is finite. Thus power rate reaching law gives a finite reaching time.

D. Speed control rate reaching (Loh and Yeung (2004))

$$(13) \quad \dot{s} = -P \cdot \exp(\beta \cdot |s|) \cdot \text{sgn}(s), \quad \beta > 0$$

and the reaching time t becomes:

$$t = \frac{1 - \exp(-\beta \cdot |s(0)|)}{\beta \cdot P}$$

The four reaching laws presented above are used in the implementation on the DC motor in order to analyze their performances.

From the time derivative of (7) and using the reaching laws defined in (10), (11), (12) and (13) yields:

$$(14) \quad \dot{s}_A = \dot{\omega}_e + \gamma \cdot \omega_e = -Q \cdot \text{sgn}(s)$$

$$(15) \quad \dot{s}_B = \dot{\omega}_e + \gamma \cdot \omega_e = -Q \cdot \text{sgn}(s) - P \cdot s$$

$$(16) \quad \dot{s}_C = \dot{\omega}_e + \gamma \cdot \omega_e = -P \cdot |s|^\alpha \cdot \text{sgn}(s)$$

$$(17) \quad \dot{s}_D = \dot{\omega}_e + \gamma \cdot \omega_e = -P \cdot \exp(\beta \cdot |s|) \cdot \text{sgn}(s)$$

From (8) and (14)-(17), and after some mathematical manipulation, we get the output commands of the sliding-mode controller:

$$(18) \quad V_{c_A} = R_a i_a + K_b \omega_m + \frac{J L_a}{K_t} [Q \cdot \text{sgn}(s) - \frac{B_m}{J} \omega_m + \gamma \omega_e]$$

$$(19) \quad V_{c_B} = R_a i_a + K_b \omega_m + \frac{J L_a}{K_t} [Q \cdot \text{sgn}(s) + P \cdot s - \frac{B_m}{J} \omega_m + \gamma \omega_e]$$

$$(20) \quad V_{c_C} = R_a i_a + K_b \omega_m + \frac{J L_a}{K_t} [P \cdot |s|^\alpha \cdot \text{sgn}(s) - \frac{B_m}{J} \omega_m + \gamma \omega_e]$$

$$(21) \quad V_{c_D} = R_a i_a + K_b \omega_m + \frac{J L_a}{K_t} [P \exp(\beta |s|) \cdot \text{sgn}(s) - \frac{B_m}{J} \omega_m + \gamma \omega_e]$$

The signum functions in the control laws were replaced by saturation functions, to reduce the chattering phenomenon (Slotine and Li (1991), Slotine and Sastry (1982)). The saturation function is defined as:

$$(22) \quad \text{sat}\left(\frac{s}{\phi}\right) = \begin{cases} \frac{s}{\phi} & \text{if } \left|\frac{s}{\phi}\right| \leq 1 \\ \text{sgn}\left(\frac{s}{\phi}\right) & \text{if } \left|\frac{s}{\phi}\right| > 1 \end{cases}$$

where constant factor ϕ defines the thickness of the boundary layer.

4. PID CONTROLLER

The time domain representation of PID controller is given in eqn. (13)

$$(23) \quad u(t) = Kp \left(\omega_e(t) + \frac{1}{Ti} \int \omega_e(t) dt + Td \frac{d\omega_e(t)}{dt} \right)$$

where $\omega_e(t)$ is the error (difference between reference input and output), $u(t)$ is the control variable, Kp is the proportional gain, Ti is the integral time constant and Td is the derivative time constant. The above equation can also be written as eqn. (14)

$$(24) \quad u(t) = Kp \omega_e(t) + Ki \int \omega_e(t) dt + Kd \frac{d\omega_e(t)}{dt}$$

Where $Kd = Kp \cdot Td$ and $Ki = Kp / Ti$. Each of these coefficients makes change in the characteristics of

the response of the system. In order to get the desired performance characteristics of the system these parameters are to be accurately tuned.

5. SIMULATION RESULTS AND DISCUSSIONS

In this section, the model of DC motor with PID controller and sliding mode controller are implemented in MATLAB/Simulink. The Simulink model of the PID controller is shown in fig. 2 and the SMC is shown in fig. 3.

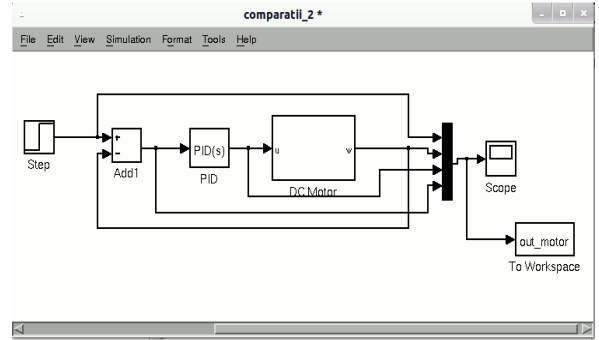

Fig.2. Simulink Block diagram of PID control

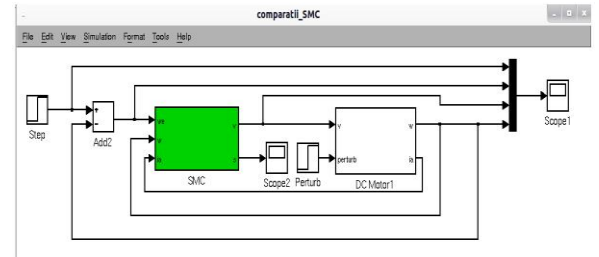

Fig.3. Simulink Block diagram of SMC control

The Figs. 4 and 5 shows the response of the system with PID controller and sliding mode controllers for a step input in presence of disturbance. Here the overshoot for SMC is considerably reduced as compared to PID controller.

6. CONCLUSIONS

The paper was focused on the performances analysis of the four laws and PID presented in Sections 3 and 4. This performance analysis is based on simulation results using MATLAB/SIMULINK software.

The simulation and experimental results show that the sliding mode controller has the fast speed response, determined by the switching surface, and is obtained without overshoot.

Analyzing the performances of the five laws it is easy to see that the most adequate laws for the DC Motor control are laws B and C (equations (11) and (12)).

By applying a disturbance, the speed response of PID controller is slightly oscillatory, whereas the speed response of SM controller type-C is smooth.

UEFISCDI, project number PN-II-PT-PCCA-2011-3.2-1680.

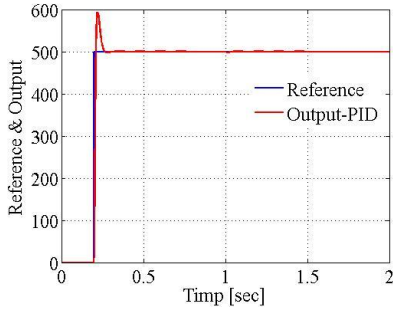

Fig.4. Step response with PID controller.

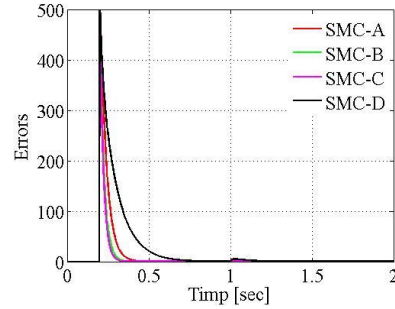

Fig.8. Error with SM controllers

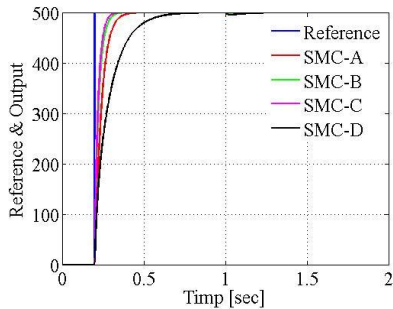

Fig.5. Step response with SM controllers.

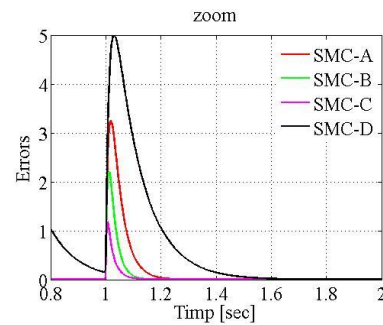

Fig.9. Zoom errors for SM controllers

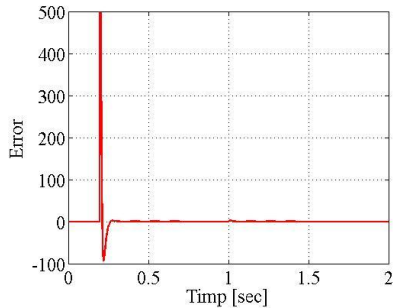

Fig.6. Error with PID controller

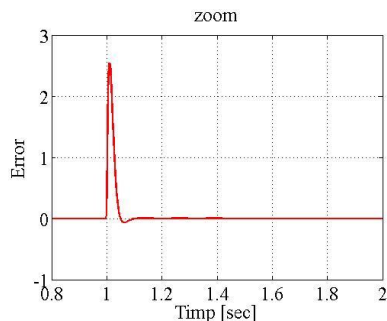

Fig.7. Zoom errors for PID controller

7. ACKNOWLEDGMENT

This work was supported by a grant of the Romanian National Authority for Scientific Research, CNDI-

8. REFERENCES

Cerruto E., A. Consoli , A. Raciti, and A. Testa (1992), "A robust adaptive controller for PM motor drives in robotic application", IEEE Trans. Ind. Applicat., vol. 28, pp. 448-454.

Gao,W. and Hung, J. (1993). Variable structure control of nonlinear systems: A new approach. IEEE Transactions on Industrial Electronics, 40, 45–55.

Grçar B., P. Cafuta, and M. Znidaric (1996), "Practical robust stabilization of PAMC servo drive based on continuous variable structure control," IEEE Trans. Energy Conversion, vol.11, pp. 708-714.

Hemati N., J. Thorp, and M.C. Leu (1990), "Robust nonlinear control of brushless dc motors for directdrive robotic applications," IEEE Trans. Ind. Electron., vol. 3, pp. 562-575.

Loh, A. and Yeung, L. (2004). Chattering reduction in sliding mode control: An improvement for nonlinear systems. WSEAS Transaction on Circuits and Systems, vol. 10, 2090–2098.

Matsui N. and H. Ohashi (1992), "DSP-based adaptive control of a brushless motor" IEEE Trans. Ind. Applicat., vol. 28, pp.448-454.

- Slotine, J. and Sastry, S. (1982). Tracking control of nonlinear systems using sliding surfaces, with application to robot manipulators. Technical report, Massachusetts Institute of Technology, Cambridge.
- Slotine, J. and Li, W. (1991). Applied Nonlinear Control. Prentice Hall, New Jersey.