

DEVELOPMENT OF WIND TURBINE SYSTEMS WITH PARALLEL CONNECTIONS OF DIFFERENT TYPES GENERATORS

**Madalin Costin*, Elena Voncila*, Ion Voncila*,
Cristian Nichita**, Grigore Fetecau***

**Faculty of Automatic Control, Computer Science, Electrical and Electronics Engineering,
„Dunărea de Jos” University of Galati, Romania , ** GREAH – Groupe de Recherche
en Electrotechnique, et Automatique du Havre, University of Le Havre, France*

e-mail: Madalin.Costin@ugal.ro

Abstract: The work paper explores the possibility of wind power conversion systems developing by parallel coupling of main different types power AC generators such as induction generator and permanent magnet synchronous one in isolated grid. Due to different electromagnetic processes underlying operation, the currents per phase developed present different differences phase, and therefore is usually obtain a low output power. It was found that optimizing the output current can be made by choosing appropriate an optimal combination of pole pairs for different generators.

Keywords: induction generator, permanent magnet synchronous generator, wind turbine systems, Psim software.

INTRODUCTION

In the present century where the energy – through its sources becomes a subject of economic, social and political debate, the concern for energy independence has become a cause of global stability.

Induction machines are currently treated in almost survey motor regime (Richter, 1958). This is a consequence of events occurring during 1950 (approximately) -1980 when the effects of global electrification process led indirectly to almost elimination of total wind turbines that were equipped with induction generators. Conventional systems,

which have gained massive with power plant development, could not take into account the induction generator machine due to the serious challenges related to ensuring its excitation. Because the generator does not have separate excitation, its own excitation required an additional reactive power source for magnetization that can be the electrical grid or a properly sized capacitor. As was showed (Ghiorghiu and Fransua, 1974) at the fifth generation of the same power must be used a synchronous compensator for reactive power. For this reason power plants do not take into account asynchronous generator as a viable solution.

The wind power conversion systems equipped with classic synchronous generator has not gained a wide development due to limitations in terms of winding size for operation in low speed range (low speed caused by wind), where the energy is delivered at frequency of 50 Hz. Basically a gearbox is necessary to adjust the low speed of turbine rotor and high speed of synchronous generator, otherwise from design phase results that there is no space to placed excitation winding in rotor slots. In this context, the excitation based on permanent magnet become a technical solution.

Parallel coupling of different types of generators is almost nonexistent in the literature survey due to various technological developments that have registered for those generators. If the theory of induction generator has been developed with the advent of induction machine, the research was suspended especially during when the power system has become decisive, for permanent magnet synchronous generator, its development took place concurrently with the development and significant decrease of the price of permanent magnets.

SETTLEMENT OF PRELIMINARY CONDITIONS FOR PARALLEL CUPLING

The structure of system compused by parallel coupling of induction and permanent magnet synchronous generator is presented in Fig. 1.

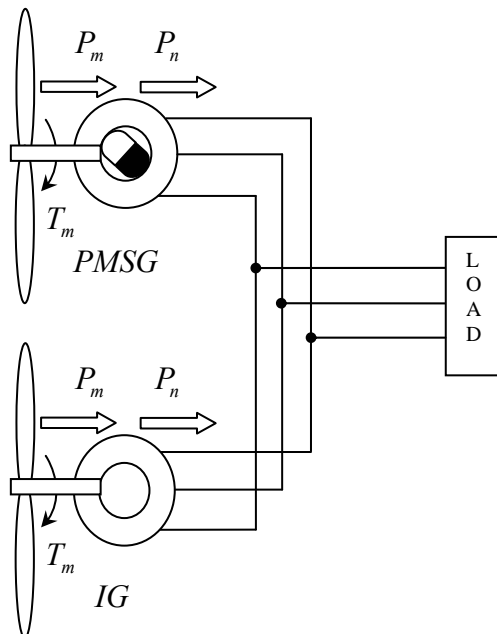

Fig.1. Sistem structure of parallel cupling

The well-know mathematical model of induction machine in dynamic regime is represent by (Babescu and Paunescu, 2001):

$$(1) \begin{cases} \frac{d\varphi_s}{dt} = -R_s i_s - u_s \\ \frac{d\varphi_{rs}}{dt} = -R_r i_{rs} + jp\omega_m \varphi_{rs} \\ \varphi_s = L_{\sigma s} i_s + \varphi_u = L_s i_s + L_m i_{rs} \\ \varphi_{rs} = L_{\sigma r} i_{rs} + \varphi_u = L_r i_r + L_m i_s \\ \varphi_u = L_m (i_s + i_{rs}) = L_m i_{ms} \\ T_a - T_{em} = J \frac{d\omega_m}{dt} = \frac{J}{p} \cdot \frac{d^2 \theta_{eg}}{dt^2} \end{cases}$$

The design of blanc capacitor is done take into consideration the reactive power required for generator magnetising:

$$(2) C = \frac{1}{\omega(x_1 + x_m)}$$

The dynamical mathematical model of induction generator is described by (Babescu and Paunescu, 2001):

$$(3) \begin{cases} \frac{di_d}{dt} = -\frac{r}{L_d} \cdot i_d + \frac{L_q}{L_d} \cdot p \cdot \omega_m \cdot i_q - \frac{1}{L_d} \cdot u_d \\ \frac{di_q}{dt} = -\frac{r}{L_q} \cdot i_q - \frac{L_d}{L_q} \cdot p \cdot \omega_m \cdot i_d - \frac{\Psi_m \cdot p \cdot \omega_m}{L_q} - \frac{1}{L_q} \cdot u_q \\ T_{em} = \frac{3}{2} \cdot p \cdot [\Psi_m \cdot i_q + (L_d - L_q) \cdot i_d \cdot i_q] \\ T_a - T_{em} = J \frac{d\omega_m}{dt} = \frac{J}{p} \cdot \frac{d^2 \theta_{eg}}{dt^2} \end{cases}$$

Parallel coupling conditions derives from the classical case of electromagnetic synchronous generators (Richter, 1958-1962):

- equality of voltage at terminals, as RMS and difference phase;
- the same successions of phases;

Supplementary at this conditions, the new one will be added as a result o the new particularities required by the new systems.

TRANSIENTS REGIMES ANALYSIS

In this section, dynamic processes using software Psim (**) has been studied. It was considered a system compused by a parallel coupling of an induction generator parallel and a permanent magnet synchronous generator to (Fig.2). The wind torque was simulated by a DC machine and the load was considered resistive and symmetrical.

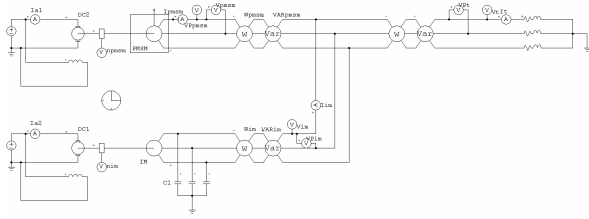

Fig.2. PSIM implementation of simulation system

Was founded by numerical simulation tests that the choice of the number of poles has a great influence on the output current, and thus, on the output power. Because there are two categories of current for each generator in part (induction current for induction generator, respectively, addition current for the supply current permanent magnet synchronous generator), the choosing an adequate number of poles for induction generator, respectively, synchronous, will cause a minimal difference phase between currents at the terminals of the both generators, and thus the total current load will be larger for a one structure conversion. Two optimal combinations values were found.

In the first case ($p_{IG} = 6$; $p_{PMSM} = 4$) the currents form obtained were presents in Fig.3.

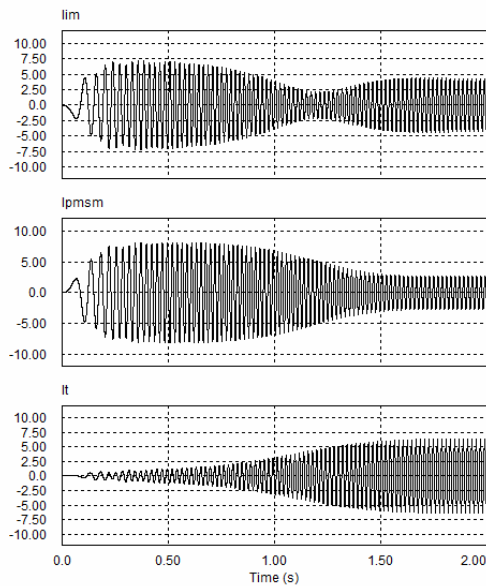

Fig.3. Phase currents

Harmonic spectrum proves that phase load current is obtain near as a sum of currents from terminals both generators (Fig.4), which lead again the minimal difference phase exist between the currents.

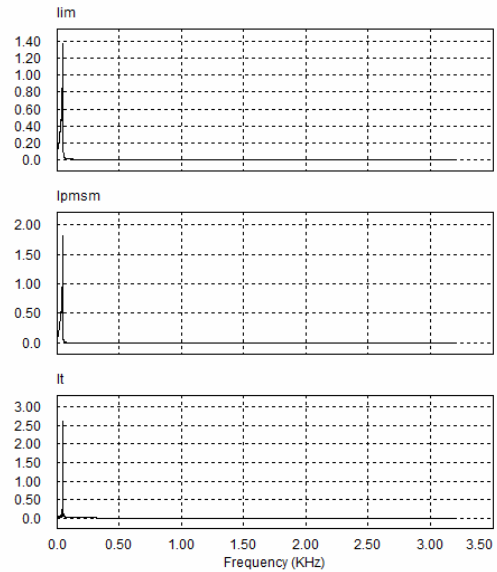

Fig.4. Currents harmonic analysis

where : I_{im} - phase current of induction machine; I_{pmsm} - phase current of permanent magnet synchronous generator; I_t - total current (load current)

The phase voltage is a symmetrical one (Fig.5):

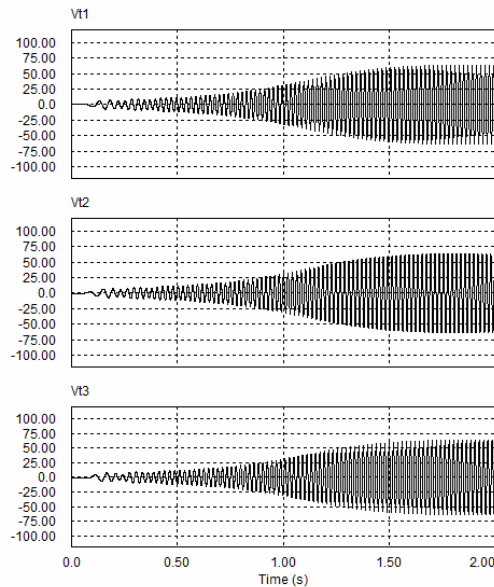

Fig.5. Load voltage

Harmonic analysis proves again the symmetry of the load voltages (Fig.).

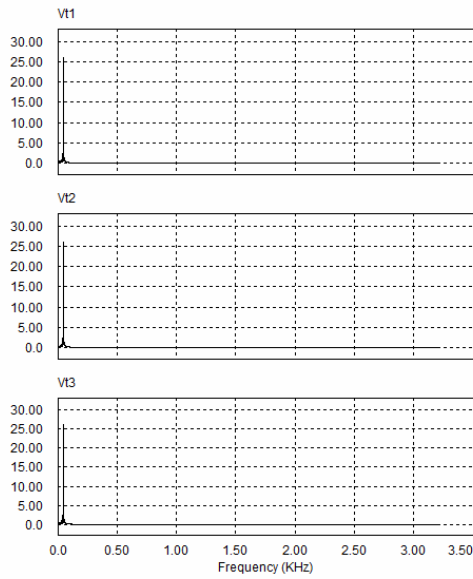

Fig.6. Voltage harmonic analysis

Puterile active (Fig.7) obtinute pe generatoare, respectiv totala, demonstreaza inca o data defazajul minim al curentilor.

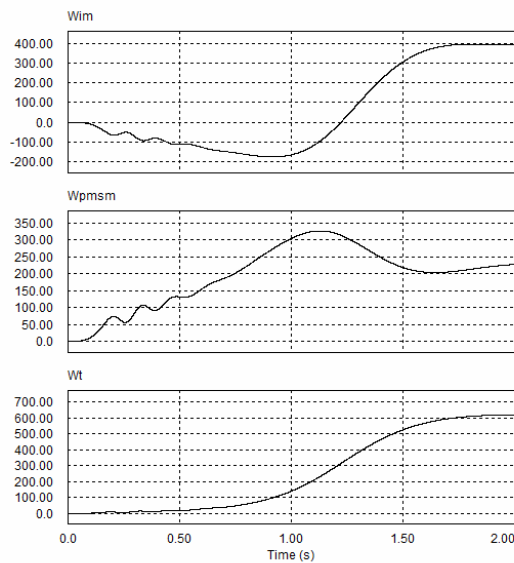

Fig.7. Active power

The reactive power flow circulation (Fig.8) is determinate by the nature of the generators (induction generator absorb, respectively, delivery for permanent magnet synchronous generator).

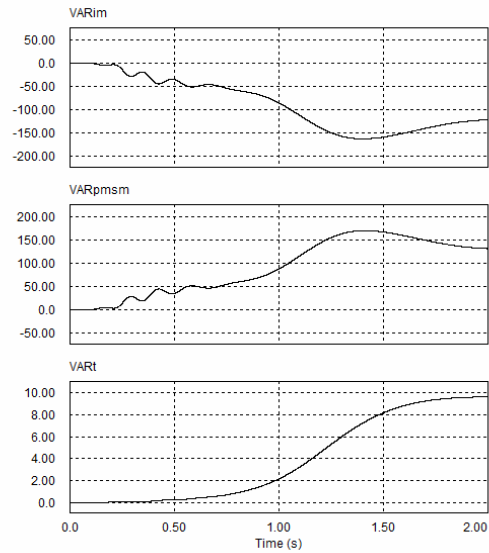

Fig.8. Reactive power

For the second case ($p_{IG} = 10$; $p_{PMSM} = 6$) were obtained high performance with different parameters. The stabilization time for current was obtained at 2.6 s.

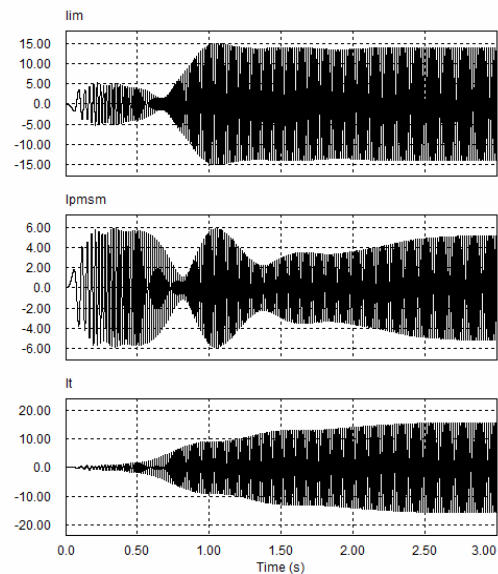

Fig.9. Phase currents

The spectrum analysis show that permanent magnet synchronous generator has an big unsymmetrical start-up current which led to an increase the harmonic content durring the start-up process.

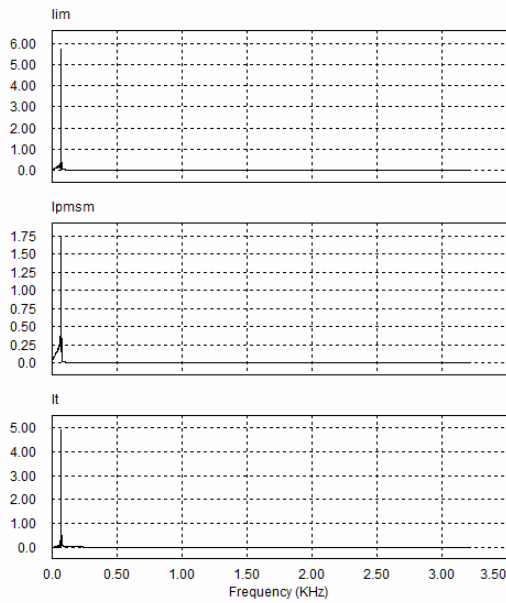

Fig.10. Currents harmonic analysis

The load voltages per phase are hold at a same values per phase (Fig.11). Because of resistive load, the transient regime of currents (Fig.3) is equal with the load voltage one (Fig.11).

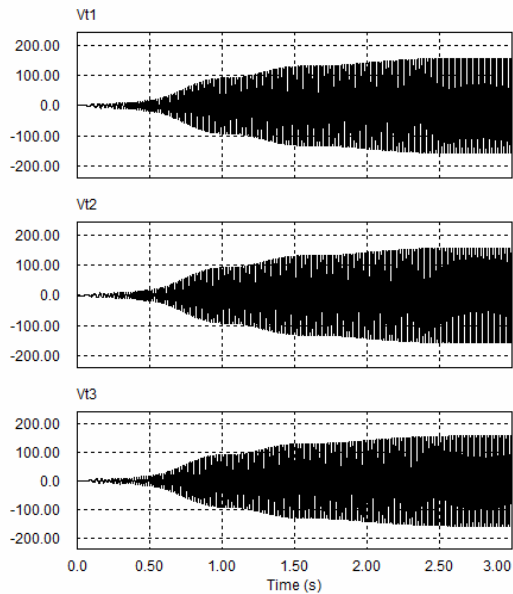

Fig.11. Load voltage

The simultaneous phenomena for each one phase is demonstrated again thought Fourier analysis (Fig.12).

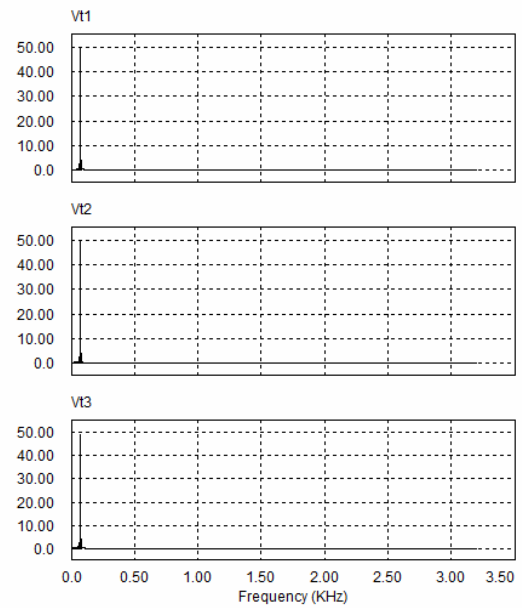

Fig.12. Voltages harmonic analysis

The active power of both generators can be founded as a sum, at the load power (Fig.13). There is a time intervals where the active power of permanent magnet synchronous generator is negative and the power flow circulate from induction generator to permanent magnet synchronous generator.

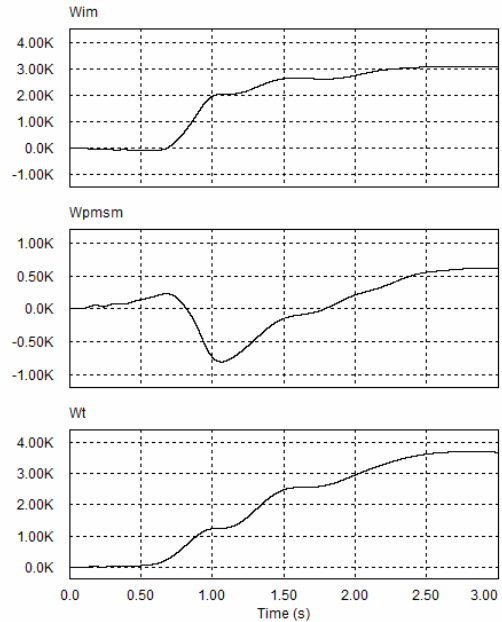

Fig.13. Active power

The reactive power flow is situating in normal limits (Fig.14).

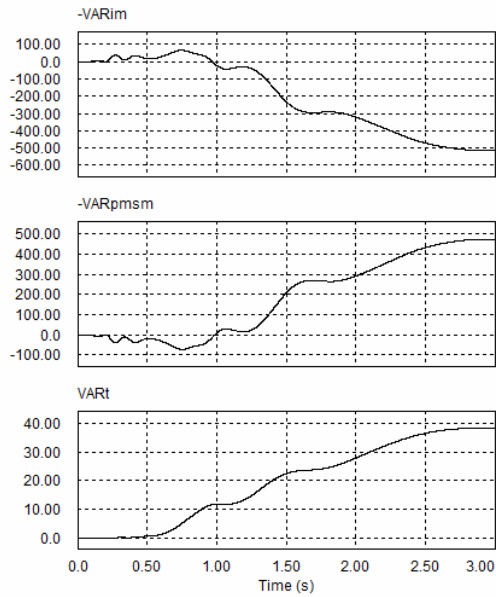

Fig.14. Reactive power

Obtained results for both optimal cases are summarized in table no. 1:

Table 1 Results obtained for optimal selection of poles combinations of different types generators

No.	Measure	Case 1	Case 2	U. M.
1	p_{IG}	6	10	<i>ad.</i>
2	P_{PMSM}	4	6	<i>ad.</i>
3	t_s	1.65	2.6	<i>s</i>
4	P_{IG}	400	3100	<i>W</i>
5	P_{PMSM}	220	700	<i>W</i>
6	P_T	610	8700	<i>W</i>
7	Q_{IG}	-120	-500	<i>VAR</i>
8	Q_{PMSM}	130	490	<i>VAR</i>
9	Q_T	9.8	39	<i>VAR</i>

As is observed, the influence of poles number combinations will effect the stabilization time on currents and power. The powers presented in table no. 1 take into consideration steady-state regime.

For all other cases, will be obtained non optimal regimes. As an example for $p_{IG} = 10$ and $P_{PMSM} = 6$ the currents will become small and active and reactive power too.

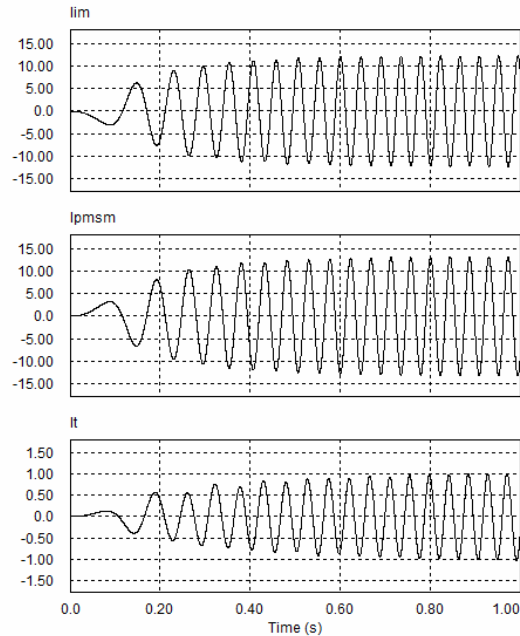

Fig.15. Phase currents of unoptimal regime

As can be seen from Fig. 15, it was observed that all non optimal combination of poles number determines a small current and power output. From this reason it is necessary to determinate the optimal selection of poles number for high performance operation.

CONCLUSION

The parallel coupling of different types AC generators can become an immediate technique solution for insulated grid development and for wind farms too, in the order to maintain in operation of induction generator and to introduce the new technologies of permanent magnet synchronous generator.

Due to different electromagnetic process for both generators, there are appears important particularities in parallel coupling process. If the stator phenomena are the same for both generators, the rotors involves different types currents (induction current for induction generator, and adduction current for permanent magnet synchronous generator) which led to a non synchronized current in stators. In the order to synchronize the currents, to find a minimal difference two optimal combinations of poles number was founded.

The development of such technique solution may have an important if will be used in addition with automatic control systems, which lead to a harmonic integration of both AC generators.

REFERENCES

- Arnold, E., (1908). *Die Wechselstromtechnik*, Springer Publishing House, Berlin. (In German)
- Babescu M. and Paunescu M. D. (2001), *Electrical Machines, Mathematical Analysis of Transients Regimes*, "Politehnica Timisoara" Publishing House, Timisoara. (In Romanian)
- Boldea, I., *The induction Machines Design Handbook*, second edition, CRC Press Publishing House.
- Boldea, I. (2005). *Variabile Speed Generators*, CRC Press Publishing House.
- Cioc, I., Nica C. (1994). *Design of Electrical Machines*, Didactic and Pedagogic Publishing House, Bucharest. (In Romanian)
- Gavrila, H. and Centea O. (1998). *Modern Theory of Electromagnetic Field and Applications*, ALL Publishing House, Bucharest. (In Romanian)
- Gheorghiu, I.S. and Fransua A., (1974) *The Treatment of Electrical Machines*, vol. 1, 2, 3, 4, Academy Publishing House, Bucharest. (In Romanian)
- Mocanu, C. (1983). *Electromagnetic Field Theory*, Didactic and Pedagogical Publishing House, Bucharest. (In Romanian)
- Postnikov, I. (1954). *Design Electric Machines*, State Energy Publishing House. Bucharest. (In Romanian)
- Pyrhonen, J., Jokinen, T., and Harabovcova, V., (2009) *Design of Rotating Electrical Machines*, John Wiley and sons.
- Richter, R.(1958-1961) *Electrical Machines*, vol. 1, 2, 3, 4, Technical Publishing House, Bucharest. (In Romanian)
- Widemann E., Kellenberger, W. (1967) *Konstruktion Elektrischer*, Springer-Verlag Publishing House, Berlin/New York. (In German)
- ***PSIM. Simulation software, POWERSYS-France-licence, 2007.

ACKNOWLEDGMENT

The work of Madalin Costin and Elena Voncila was supported by Project SOP HRD-EFICIENT 61445/2009.

Appendix 1. Simulation Parameters

Squirrel-cage Ind. Machine

Parameters | Other Info | Color

Squirrel-cage induction machine [Help]

Parameter	Value	Display
Name	M1	<input type="checkbox"/>
Rs (stator)	0.294	<input type="checkbox"/>
Ls (stator)	0.00139	<input type="checkbox"/>
Rr (rotor)	0.156	<input type="checkbox"/>
Lr (rotor)	0.00074	<input type="checkbox"/>
Lm (magnetizing)	0.041	<input type="checkbox"/>
No. of Poles P	6	<input type="checkbox"/>
Moment of Inertia	0.4	<input type="checkbox"/>
Torque Flag	1	<input type="checkbox"/>
Master/Slave Flag	1	<input type="checkbox"/>

Permanent Magnet Sync. Machine

Parameters | Other Info | Color

Permanent-magnet sync. machine [Help]

Parameter	Value	Display
Name	PMSM31	<input type="checkbox"/>
Rs (stator resistance)	4.3	<input type="checkbox"/>
Ld (d-axis ind.)	27m	<input type="checkbox"/>
Lq (q-axis ind.)	67m	<input type="checkbox"/>
Vpk / krpm	98.67	<input type="checkbox"/>
No. of Poles P	4	<input type="checkbox"/>
Moment of Inertia	1.79m	<input type="checkbox"/>
Mech. Time Constant	10	<input type="checkbox"/>
Torque Flag	1	<input type="checkbox"/>
Master/Slave Flag	1	<input type="checkbox"/>

Capacitor

Parameters | Other Info | Color

Capacitor [Help]

Parameter	Value	Display
Name	C1	<input checked="" type="checkbox"/>
Capacitance	0.0002	<input type="checkbox"/>
Init. Cap. Voltage	0	<input type="checkbox"/>
Current Flag	0	<input type="checkbox"/>

Resistor

Parameters | Other Info | Color

Resistor [Help]

Parameter	Value	Display
Name	R	<input checked="" type="checkbox"/>
Resistance	10	<input type="checkbox"/>
Current Flag	0	<input type="checkbox"/>